

Top View of Assembly

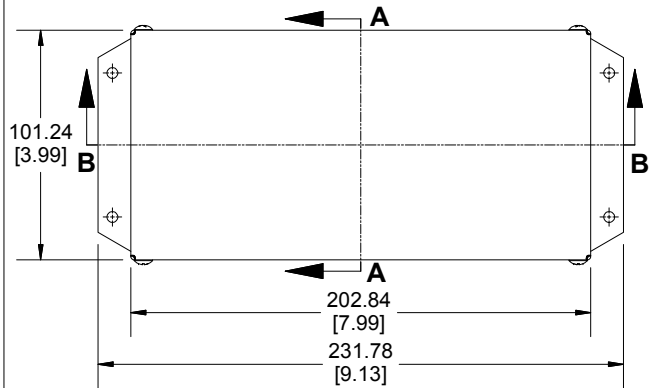

**SECTION A-A
End View of Assembly**

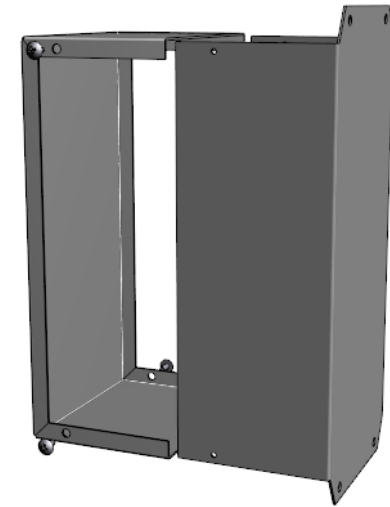
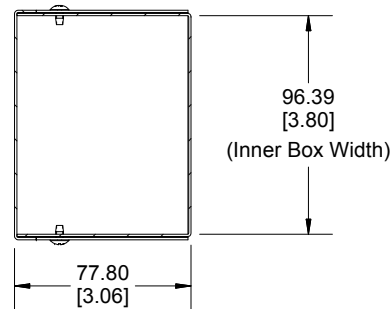

**SECTION B-B
Side View of Assembly**

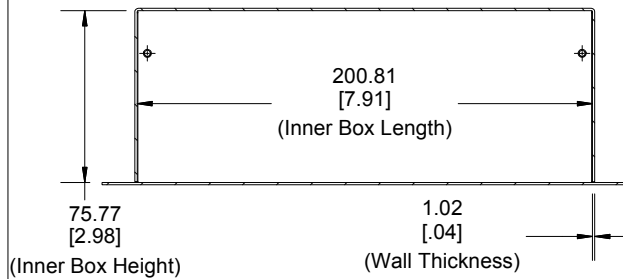

Side View of Flanged Bottom

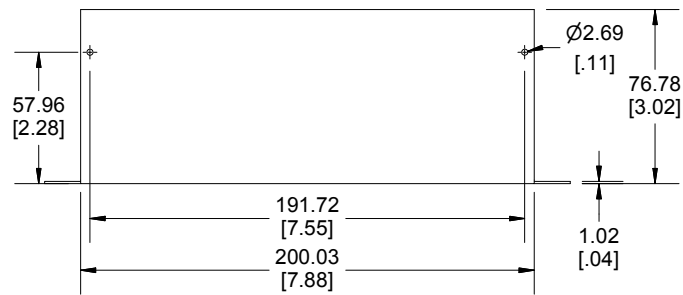

Side View of Cover

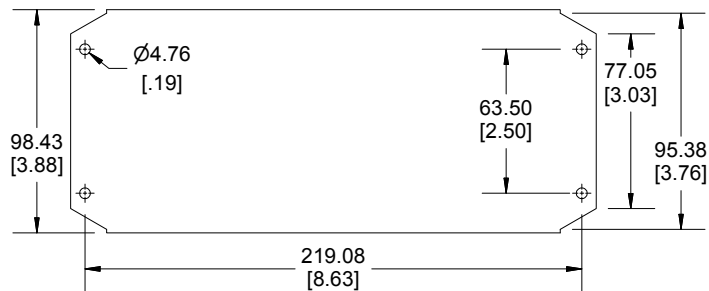
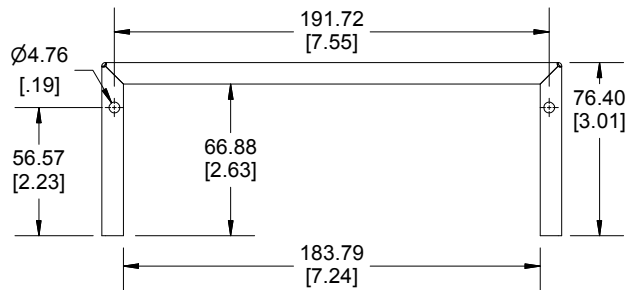

Enclosures can be Factory Modified (Milling, Drilling, Printing etc.)
Contact Factory mjm@hammondmfg.com for quotes
Solid models of this enclosure available in STEP or IGES.

NOTE

Purchased assembly includes flanged bottom, cover and 4 cover screws.
Bottom and cover are made from 0.04" Aluminum Panels.

PART NUMBERS

1411FBS Enclosure	
Natural Finish Enclosure	1411FBSU
Black Enclosure	1411FBSBK
ACCESSORIES	
Plated Cover Screws (Pkg 6)	1421J6
[6-32 x 1/4" Self-Tapping Screws]	
Black Cover Screws (Pkg 6)	1421J6BK
[6-32 x 1/4" Self-Tapping Screws]	

**HAMMOND
MANUFACTURING™**
1411FBS
www.hammondmfg.com

Dimensions:
mm
[inches]